

B3IS5466SYF Fitting Instruction

FV/FH E5 ISJZ 2011 -

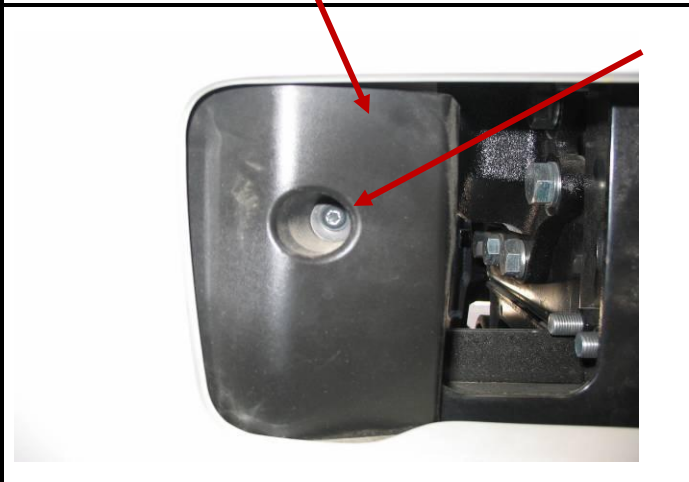

PROCEDURE TO REMOVE BUMPER BAR
REMOVE COVERS, ONE EACH SIDE
DRIVE SIDE SHOWN

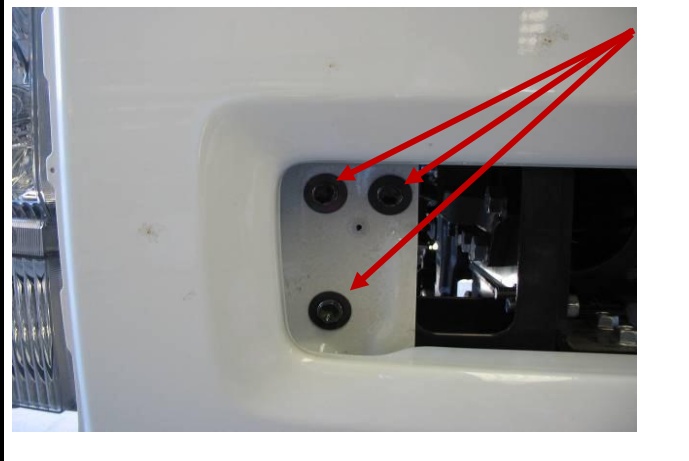

REMOVE 3 BOLTS PER SIDE
RHS SHOWN

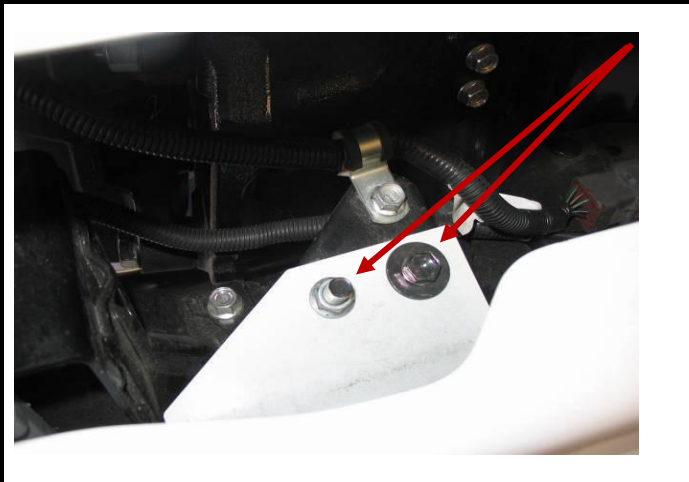

REMOVE BOLT AND NUT

B3IS5466SYF Fitting Instruction

FV/FH E5 ISJZ 2011 –



REMOVE BOLT AND NUT
DRIVER SIDE SHOWN
REPEAT ON PASSENGER SIDE



REMOVE BOLT
DRIVER SIDE SHOWN
REPEAT ON PASSENGER SIDE

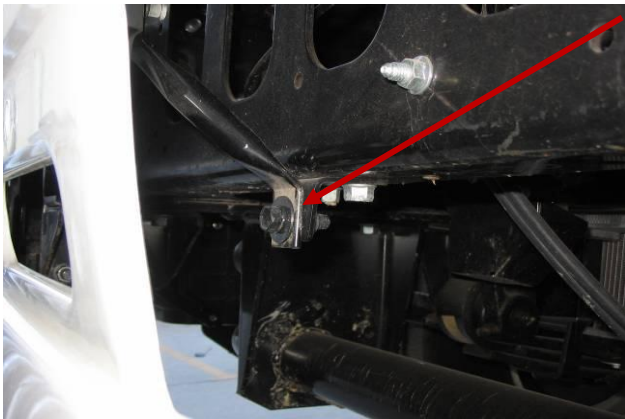

REMOVE BOLT FROM BRACE
BUMPER BAR CAN NOW BE REMOVED



BUMPER BAR REMOVED
DRIVER SIDE SHOWN
REPEAT ON PASSENGER SIDE

B3IS5466SYF Fitting Instruction

FV/FH E5 ISJZ 2011 –

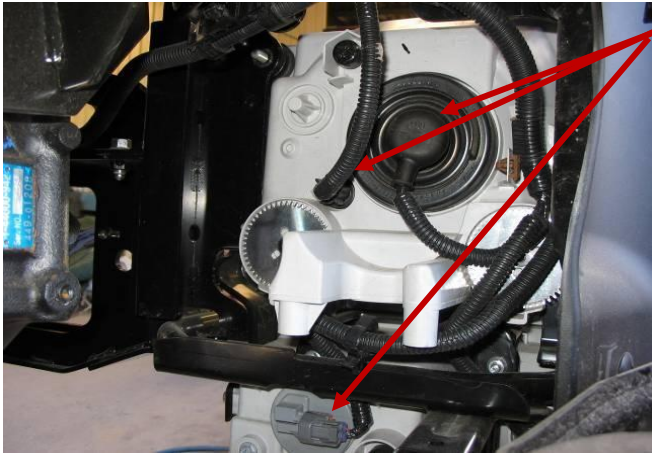

DISCONNECT WIRING HARNESS AND HARNESS CLIP FROM HEADLAMPS



REMOVE BOLTS FROM HEADLAMP MOUNTING BRACKETS AND REMOVE

REMOVE TOW HOOK FROM PASSENGER SIDE



HEADLAMPS AND BRACKETS REMOVED



HEADLAMP AND BRACKET REMOVED

REMOVE HEADLAMP FROM BRACKET

LEAVE RUBBER MOUNT ATTACHED TO HEADLAMP 4 PLACES

B3IS5466SYF Fitting Instruction

FV/FH E5 ISJZ 2011 –



REMOVE HEADLAMP TRIM FROM ORIGINAL BUMPER BAR AND FIT TO BULLBAR USING ORIGINAL RETAINING CLIPS

TO ASSIST RETENTION OF TRIM, SECURE TRIM USING ADDITIONAL SCREWS PROVIDED

SCREW SELF TAPPING SCREWS THROUGH TRIM OUTER FACE INTO BULLBAR



FIT HEADLAMP TO BULLBAR

DRIVER SIDE SHOWN

REPEAT ON PASSENGER SIDE



ADAPTOR BRACKET

ORIGINAL RUBBER MOUNT AND NUT

1 x 8 x 25mm BOLT, NUT AND WASHER

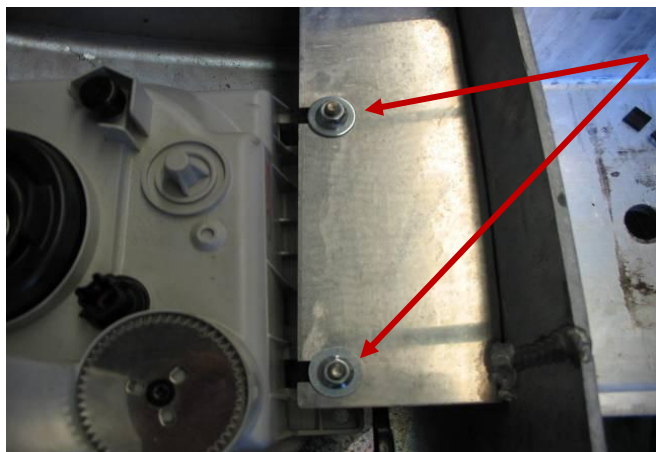

ORIGINAL RUBBER MOUNTS AND NUTS USE LARGE WASHER UNDER NUT

B3IS5466SYF Fitting Instruction

FV/FH E5 ISJZ 2011 –

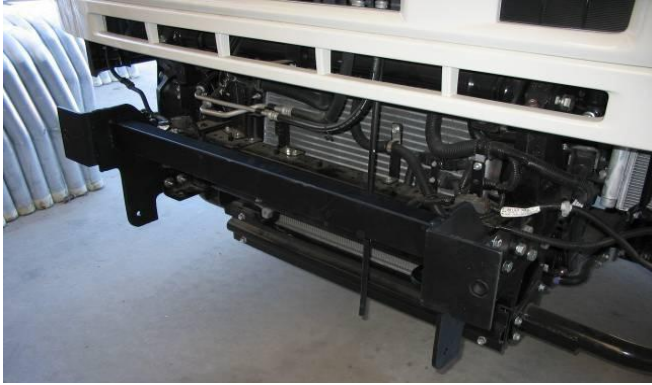

FIT BULLBAR MOUNT TO CHASSIS

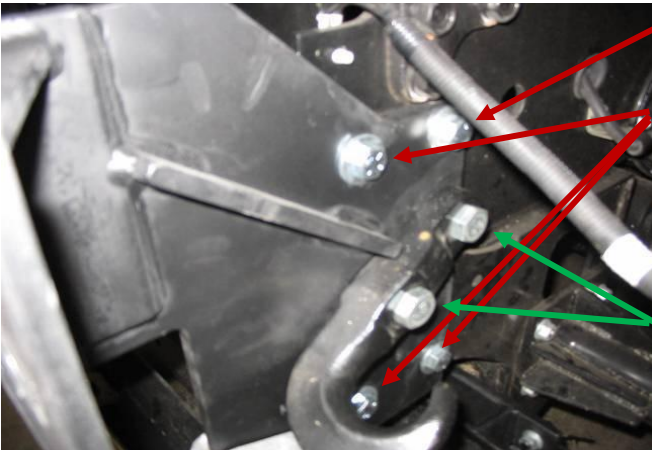

ONE M12 x 45 x 1.25 BOLT AND WASHER
THREE 1/2" x 2" BOLTS, WASHERS, ONE NYLOC NUT (TWO WASHERS PER BOLT, ONE UNDER HEAD AND ONE UNDER NUT)

PARTLY TIGHTEN BOLTS

REFIT TOW HOOK USING ORIGINAL BOLT/NUT ON REAR HOLE AND M16 x 90 x 1.5, FLAT AND SPRING WASHER AND ORIGINAL NUT ON FRONT HOLE

PARTLY TIGHTEN BOLTS
(PASSENGER SIDE SHOWN)

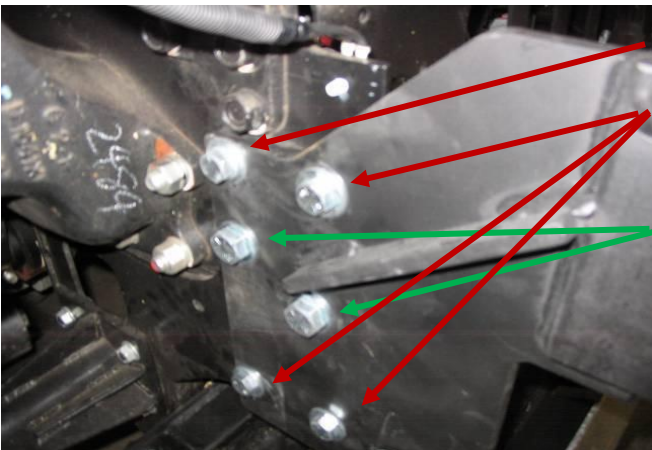

ONE M12 x 45 x 1.25 BOLT AND WASHER
THREE 1/2" x 2" BOLTS, WASHERS, ONE NYLOC NUT (TWO WASHERS PER BOLT, ONE UNDER HEAD AND ONE UNDER NUT)

TWO 5/8" X 2 1/4" BOLTS, WASHERS AND NYLOC NUTS

PARTLY TIGHTEN BOLTS
(DRIVER SIDE SHOWN)

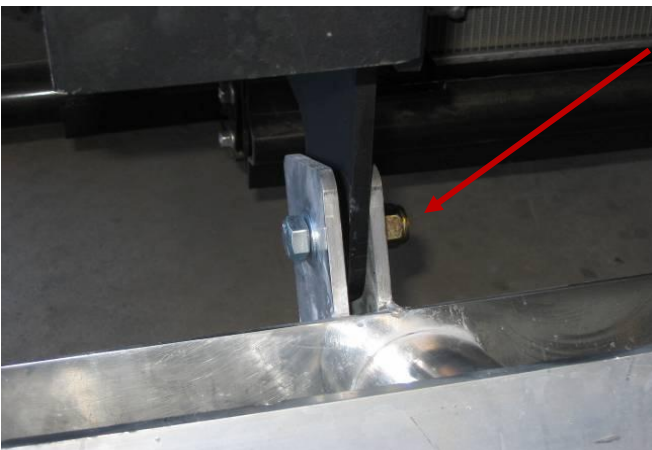

FIT BULLBAR TO MOUNT USING 5/8" X 2 1/2" BOLTS, WASHERS AND NYLOC NUTS

TIGHTEN NUTS ENOUGH TO ALLOW THE BULLBAR TO PIVOT

DRIVER SIDE SHOWN

REPEAT ON PASSENGER SIDE

B3IS5466SYF Fitting Instruction

FV/FH E5 ISJZ 2011 –



RECONNECT WIRING HARNESS AND CLIPS TO HEADLAMPS

CABLE TIE HARNESS TO HEADLAMP



RAISE AND SECURE BULLBAR

LOCK BULLBAR IN PLACE USING TWO EYEBOLTS SUPPLIED

ALIGN BULLBAR TO VEHICLE ENSURING BULLBAR GAPS ARE EQUAL

TORQUE ALL FASTENERS

LOCATION	SIZE	TORQUE
BULLBAR MOUNT	5/8"	150Nm
BULLBAR MOUNT	12mm	130Nm
BULLBAR MOUNT	1/2"	130Nm



FIT WARNING LABEL TO DOOR



FIT WARNING LABEL TO BACK OF CAB

B3IS5466SYF Fitting Instruction

FV/FH E5 ISJZ 2011 –



REMOVE FRONT UNDER RUN PROTECTION DEVICE (FUPD) FROM VEHICLE

FOUR NUTS, TWO PER SIDE, RETAIN NUTS

DRIVER SIDE SHOWN

REPEAT ON PASSENGER SIDE

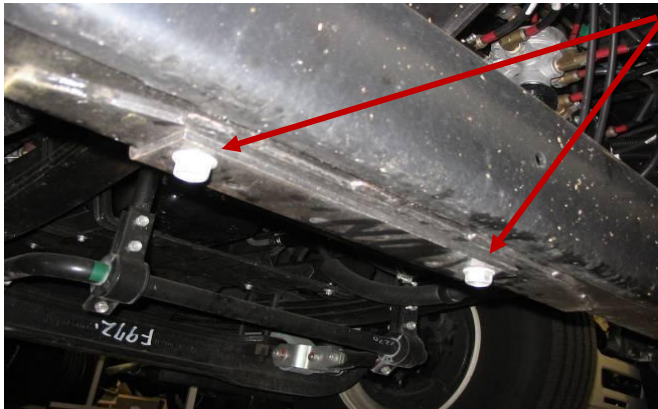

FOUR NUTS, TWO PER SIDE, RETAIN NUTS

DRIVER SIDE SHOWN

REPEAT ON PASSENGER SIDE



FUPD BAR REMOVED

PASSENGER SIDE SHOWN, DRIVER SIDE THE SAME



FUPD SPACER BRACKET

DRIVER SIDE SHOWN, PASSENGER SIDE IS A MIRROR OF THIS

B3IS5466SYF Fitting Instruction

FV/FH E5 ISJZ 2011 –

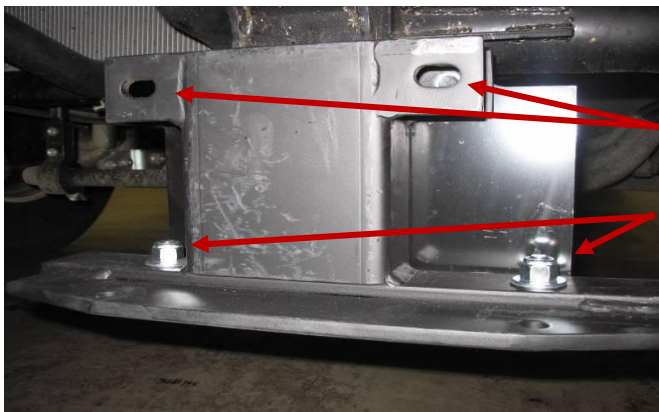

FIT SPACER BRACKET TO VEHICLE AS SHOWN

ORIGINAL NUTS, TWO PER SIDE ONTO WELDED STUDS

TWO 1/2" X 1 1/2" BOLTS, WASHERS AND NYLOC NUTS, TWO SETS PER SIDE

PASSENGER SIDE SHOWN

DRIVER SIDE IS THE SAME

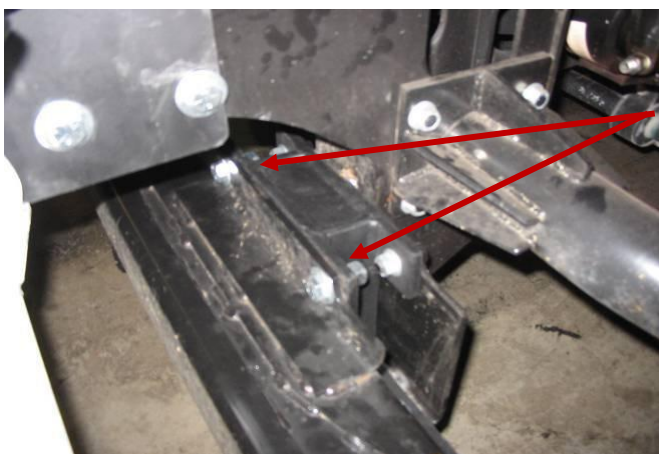

REFIT FUPD TO VEHICLE

TWO 1/2" X 1 1/2" BOLTS, WASHERS AND NYLOC NUTS, TWO SETS PER SIDE

REFIT ORIGINAL BOLTS UNDERNEATH FUP, TWO PER SIDE

DRIVER SIDE SHOWN



FUPD REFITTED TO VEHICLE

DRIVER SIDE SHOWN



TORQUE ALL FASTENERS

LOCATION	SIZE	TORQUE
FUPD MOUNT	12mm	130Nm
FUPD MOUNT	1/2"	130Nm

B3IS5466SYF Fitting Instruction

FV/FH E5 ISJZ 2011 –

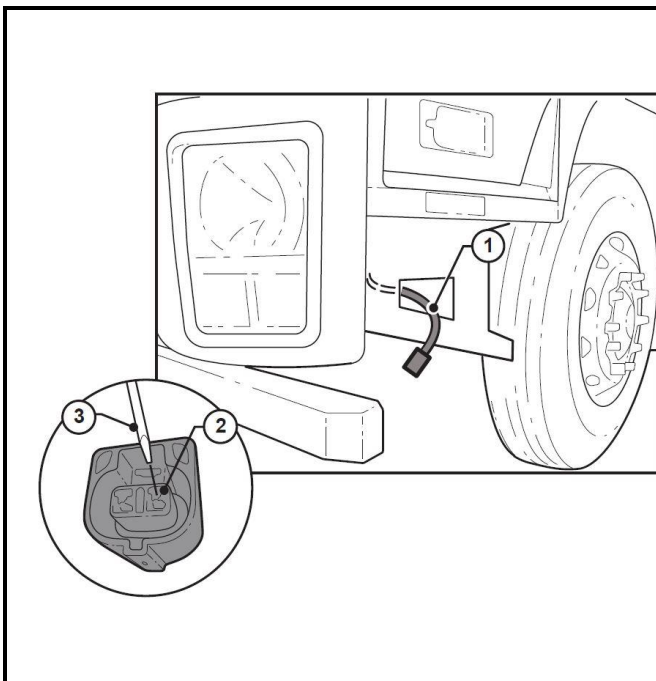

AT THE LEFT HAND FRONT OF THE VEHICLE LOCATE THE TWO-WAY FEMALE CONNECTOR CONNECTED TO THE FRONT CORNERING LAMP ASSEMBLY (1).

NOTE THE ORIENTATION OF THE GREEN AND GREEN/BLACK WIRES OF THE CONNECTOR. LOOKING AT THE REAR OF THE CONNECTOR; GREEN/BLACK ON THE LEFT AND GREEN ON THE RIGHT.

AT THE FRONT OF THE CONNECTOR LOCATE THE RECESSES (2) ABOVE EACH TERMINAL. REMOVE ONE TERMINAL AT A TIME USING A JEWELLERS SCREWDRIVER (3) TO RELEASE THE LOCKING TAB INSIDE EACH RECESS. AT THE SAME TIME LIGHTLY PULL THE WIRE OUT OF THE CONNECTOR.

PUT THE CONNECTOR ASIDE AS IT WILL BE USED LATER.

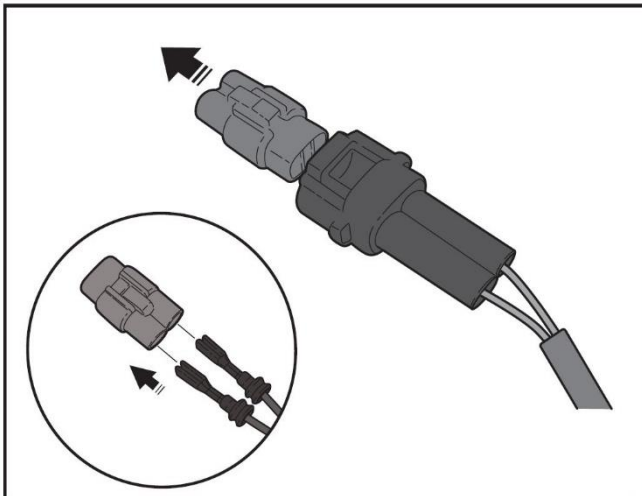

LOCATE ONE WIRE HARNESS EXTENSION FROM THE KIT. REMOVE THE WHITE FEMALE TWO-WAY CONNECTOR FROM THE WIRE HARNESS EXTENSION.

INSERT THE FEMALE GREEN/BLACK AND GREEN TERMINALS REMOVED FROM BODY HARNESS CONNECTOR IN PREVIOUS STEP INTO THE WHITE TWO-WAY CONNECTOR.

NOTE: MATCH THE WIRE COLOURS OF THE WIRE HARNESS EXTENSION AND THE BODY HARNESS. TERMINALS WILL ONLY GO INTO THE CONNECTOR ONE WAY AND WILL NOT INSERT INTO THE CONNECTOR EASILY. IF THERE IS ANY RESISTANCE DO NOT FORCE THE TERMINALS INTO THE CONNECTOR. INSERT UNTIL A CLICK IS HEARD, LIGHTLY PULL ON WIRE TO ENSURE POSITIVE ENGAGEMENT.

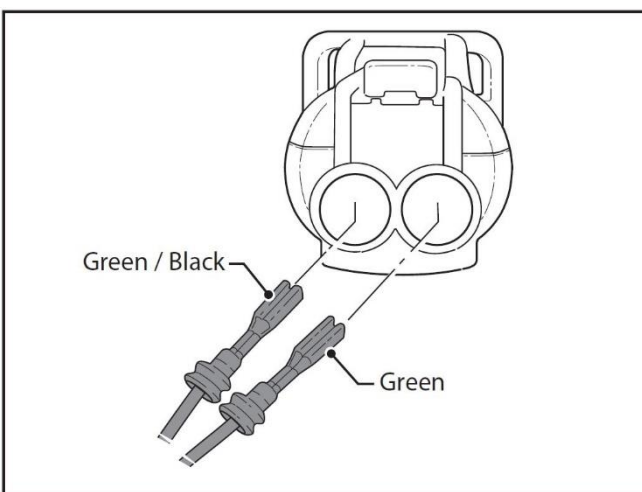

INSERT THE FEMALE TERMINALS OF THE PATCH HARNESS INTO THE VACANT CONNECTOR REMOVED FROM THE BODY OF THE HARNESS TWO STEPS EARLIER. FIT TERMINALS IN THE SAME ORIENTATION AS THEY WERE REMOVED AND FOLLOW THE SAME PROCEDURE IN THE PREVIOUS STEP.

CONNECT THE WIRE HARNESS EXTENSION CONNECTOR TO THE BODY HARNESS.

REPEAT THE PREVIOUS TWO STEPS FOR THE OTHER SIDE OF THE VEHICLE.

ONCE THE VEHICLE IS RE-ASSEMBLED TEST THE FRONT CORNERING LAMPS TO MAKE SURE THAT THEY ARE FUNCTIONING CORRECTLY.

B3IS5466SYF Fitting Instruction

FV/FH E5 ISJZ 2011 –



FITTING KIT

Qty	Length	Diameter	Thread Pitch	Description
6	25mm	8mm	1.25mm	Metric Bolt Grade 8H/T
6		8mm	1.25mm	Metric ZP Nut
10		8mm		Flat Washer
6		8mm		Spring Washer
4	3/4"	6 Gauge		Black Screws
2	45mm	12mm	1.25mm	Metric Bolt Grade 8H/T
6	2"	1/2"	UNC	Bolt Grade 8H/T
6		1/2"	UNC	Nyloc Nut
14		1/2"		H/D Flat Washer
2		1/2"		Spring Washer
2	2 1/4"	5/8"	UNC	Bolt Grade 8H/T
2		5/8"	UNC	Nyloc Nut
4		5/8"	UNC	Flat Washer
1		16mm		Flat Washer
1		16mm		Spring Washer
1	90mm	16mm	1.5mm	Metric Bolt Grade 8H/T
1	Fitting Instructions			
2	Tilt Bullbar Warning Stickers			
2	Rectangle Light Bracket			
2	Hook Light Bracket			
2	Long Cable Ties			
1	Patch Harness			P/N ICH92956698
SEALED IN CLEAR BAG AND BOXED WITH FUPS EXTENSION BRACKETS				

FUPS EXTENSION				
8	1 1/2"	1/2"	UNC	Bolt Grade 8H/T
8		1/2"	UNC	Nyloc Nut
16		1/2"		H/D Flat Washer
SEALED IN CLEAR BAG AND ADD TO BOX WITH FUPS EXTENSION BRACKETS				
1	Passenger Side FUPS Extension Bracket			
1	Driver Side FUPS Extension Bracket			
PUT IN BOX AND ADD TO BULLBAR CARTON				

ATTACHED TO BULLBAR					
2		3/4"	UNC	Eyebolt Grade 8H/T	P/N ICEYEBOLT
2		3/4"		Flat Washer	
2	2 1/2"	5/8"	UNC	Bolt Grade 8H/T	
2		5/8"	UNC	Nyloc Nut	
4		5/8"		Flat Washer	
ADDITIONS					
1	Steel Bullbar Mount				

**B3IS5466SYF Fitting Instruction
FV/FH E5 ISJZ 2011 –**



**DESPATCH CHECKLIST
B3IS5466SYF
ISUZU FV/FH E5 ISJZ 2011-**

Work Order No:	
Finish:	
Transport:	
Due Date:	

BK	_____	2	Rectangle Light Brackets – In Bolt Kit
BK	_____	2	Hook Light Brackets – In Bolt Kit
BK	_____	1	Passenger Side FUPS Extension Bracket – Boxed With FUPS Kit
BK	_____	1	Driver Side FUPS Extension Bracket – Boxed With FUPS Kit
BK	_____	1	Bolt Kit – Boxed With FUPS Brackets and Boxed With FUPS Kit
OC	_____	1	Steel Mounting Bracket
OC	_____	2	3" Overrides (CA01 Plastic)
OC	_____	2	Custom Alloy Badges
WR	_____	2	Eyebolts (³ / ₄ " UNC ZP) and Washers – Fitted To Bar
WR	_____	2	2½" x ⁵ / ₈ " UNC Bolt Grade 8H/T – Fitted To Bar
WR	_____	2	⁵ / ₈ " Nyloc Nut – Fitted To Bar
WR	_____	4	⁵ / ₈ " Flat Washer – Fitted To Bar
WR	_____	1	Bolt Kit Box – Taped to Bar

**See other side of this page for photos of all mounts
IS THIS PRODUCT "THE BEST IT CAN BE"?
IF NO FIX BEFORE CONTINUING**

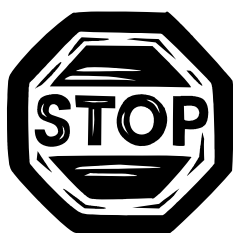

Wrapper's Checker's
Initials Initials

ALL PARTS CHECKED AND COMPLETED BY:

NUTS AND BOLTS: _____ DATE: ___/___/___

ORDER CONTROL: _____ DATE: ___/___/___

FINAL WRAP CHECK: _____ DATE: ___/___/___

B3IS5466SYF Fitting Instruction

FV/FH E5 ISJZ 2011 –

STEEL MOUNT

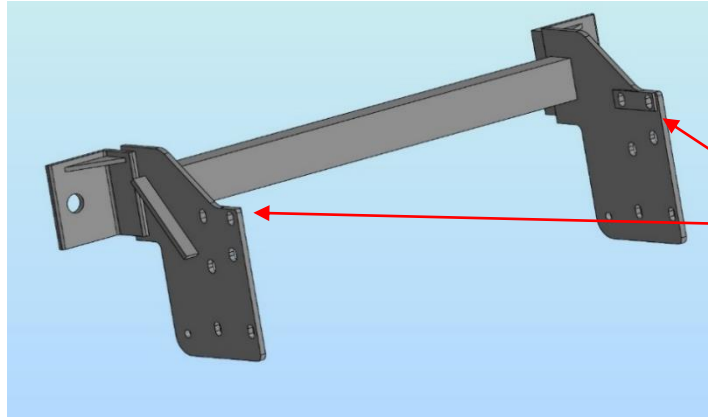

Inside of Mount

FUPS EXTENSION BRACKETS (IN BOLT KIT BOX)



LIGHT BRACKETS (IN BOLT KIT)



Wrapper's Initials

Checker's Initials